

PRESEP AIR SEPARATOR VTP

- High efficiency
- Low costs for operation and maintenance
- High operating reliability
- High sharpness of separation
- High capacity

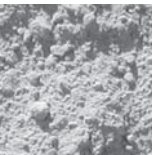



Air separator VTP 2400 at the cement grinding plant with 100t/h capacity – Kujawy, Poland

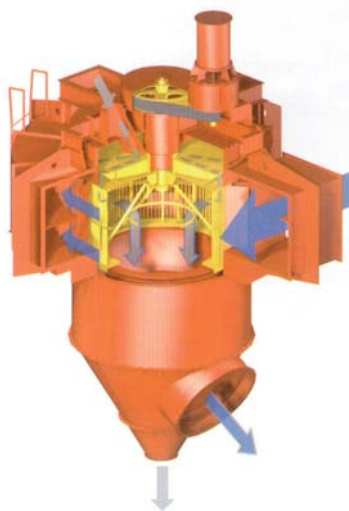

3D model of VTP air separator

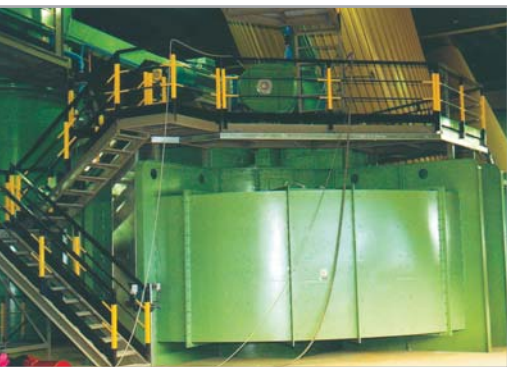

Air separator VTP 4200 at the raw material grinding plant with a capacity of 300t/h – Sesto Campano, Italy

Separator application

The PRESEP air separator VTP designed by PSP Engineering is a dynamic air separator used in circulation mechanical grinding plants with a ball mill or in independent separation circuits.

Characteristics of the PRESEP air separator VTP:

- High efficiency and sharpness of separation
- The Tromps curve with a bypass lower than 10% and great steepness guarantees high output and efficiency of separation
- Energy savings of the grinding plant with a fineness of separation up to 40%
- Compact structure means less weight and built up space
- Low cost of installation
- Wear parts are effectively protected against abrasion and can be easily replaced
- Negligible maintenance
- Suitable for abrasive materials
- Sorted material can be effectively dried and cooled
- Separate a greater range of grain sizes from 20 – 300 μm
- Adjust grain size distribution during operation
- Improved grain size distribution of raw meal
- Favorable conditions for the burning process

Design of the VTP separator

Material inlet

The material inlet at the distribution plate is designed with one or two inlets, which are positioned opposite of each other. The inlet is shaped to uniformly distribute the material within the separator and to improve separation efficiency. Larger separators are designed with as many as four inlets.

Separation air supply

The regulation flaps positioned at the separator inlet maintain a uniform air distribution along the longitudinal axis of the spiral chamber. Distribution louvers are positioned at the inlet. The louvers guide the air into the inlet duct to reduce turbulence. The distribution louvers are replaceable and are made of wear resistant material or fitted with hard facing.

Wear resistant lining of the separator

Surfaces, which are exposed to wear, are protected with wear-resistant lining according to the abrasiveness of the material. Steel lining is used for materials of with common wear properties while basalt, ceramic lining, or hard facing is used for abrasive materials.

Rotor

The welded rotor of the separator is a heavy-duty and rugged piece. By the rotating action of the rotor the material is separated into the final product and coarse particles. The rotor blades prevent coarse particles from passing to the inner space of the rotor cage where only the final product is taken by air flow. The coarse material is discharged from the separator into a discharge hopper to be reprocessed. The rotor is mounted on a shaft which is seated on two radial and one axial bearing. The rotor is equipped with blades manufactured of high-alloyed material and fitted with wear resistant coating.

Final product discharge

The final product together with the separation air is discharged from the inside part of the rotor that is equipped with adjustable sealing in its lower part. The coarse product that is to be returned to the grinding process falls freely to the collecting cone at the bottom.

Separator drive

The separator rotor speed is regulated according to the output fineness and size of the finish product. The electrical drive is either direct or belt driven. A gearbox is used for larger sizes.

PRESEP air separator VTP

Separator functions

The material required for separation is supplied through one, two or four inlets onto the distribution plate positioned over the separator rotor. The distribution plate distributes the material along the periphery of the rotor in a uniform manner while single particles are accelerated in tangential and radial directions and thrown on the scattering wall. Upon impact the particles burst and are fanned out in the separation space. This design of the material inlet guarantees a uniform charge of the separation zone and enhances the efficiency of the separator.

Air or other gases are supplied to the working space of the separator via a spiral box and distribution louvers. When directed in such a manner, the air entrains material passing transversally through the separator and carries fine particles along the periphery of the rotor and through the cage for discharge to the cyclones or filter. Larger particles do not pass through the rotor cage but instead fall along the rotor axis to the discharge hopper for reprocessing.

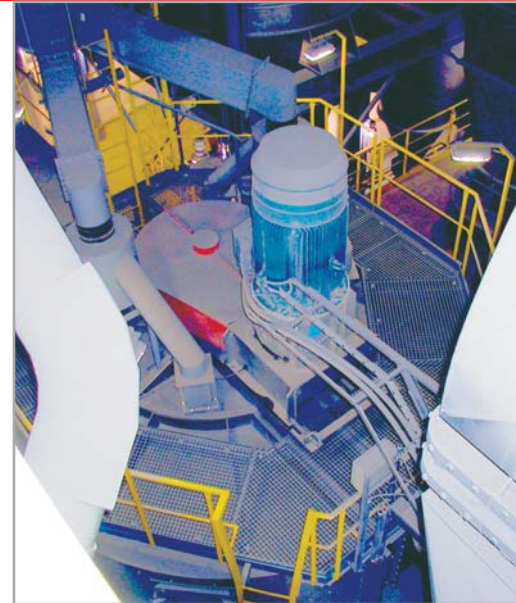

Air separator VTP 2700 at the cement grinding plant with a capacity of 80t/h – CEMMAC Horné Srnie, Slovakia

Parameters of PRESEP separator VTP

Type	Amount supplied (t/h)	Air amount (m ³ /h)	Motor output (kW)	Capacity in cement 3200 BI (t/h)	Capacity in material 12 % R90 (t/h)
VTP 500	7.7	4300	7.5	3.1	4.1
VTP 600	10.5	5860	11.0	4.3	5.5
VTP 700	15.2	8420	11.0	6.2	8.0
VTP 800	21.0	11,630	15.0	8.5	11.0
VTP 950	27.0	14,980	18.5	11.0	14.5
VTP 1100	39.0	21,655	30.0	16.0	20.5
VTP 1300	58.0	32,135	37.0	23.5	30.5
VTP 1500	76.0	42,215	45.0	31.0	40.0
VTP 1650	95.5	53,000	55.0	39.0	50.0
VTP 1800	117.0	64,800	75.0	47.0	61.0
VTP 1950	140.0	77,900	90.0	57.0	74.0
VTP 2100	166.0	91,875	110.0	67.0	87.0
VTP 2250	194.0	107,550	132.0	79.0	102.0
VTP 2400	224.0	124,325	160.0	90.0	117.0
VTP 2550	251.5	139,675	200.0	102.0	133.0
VTP 2700	286.0	158,690	200.0	116.0	150.0
VTP 2900	324.0	180,165	250.0	132.0	172.0
VTP 3100	386.0	214,775	315.0	157.0	214.0
VTP 3300	443.0	246,145	315.0	179.0	233.0
VTP 3600	528.0	293,490	350.0	214.0	278.0
VTP 3900	628.0	348,935	400.0	255.0	331.0
VTP 4200	736.0	409,170	450.0	299.0	388.0
VTP 4500	846.0	469,975	500.0	344.0	447.0
VTP 4900	1014.0	563,535	630.0	412.0	536.0

Separation characteristics of different types of materials are evaluated in the proprietary testing and simulation facility at PSP Engineering.

Comparison of sharpness and efficiency of separation with the separator of the former design and a new separator PRESEP at the cement plant Anhovo, Slovenia, for type II/B-S42.5 cement

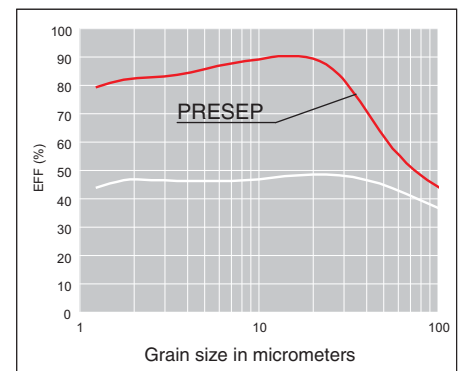
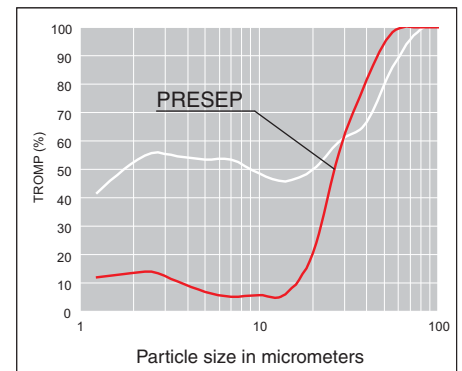

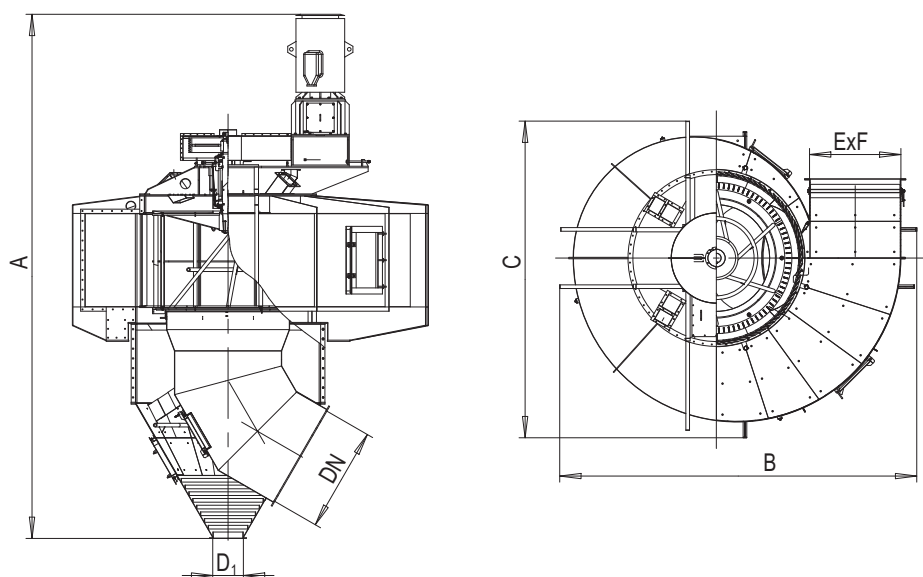

Basic dimensions of PRESEP separators VTP

Type	A (mm)	B (mm)	C (mm)	E x F (mm)	DN (mm)	D ₁ (mm)
VTP 500	2780	1200	1200	270 x 295	180 x 370	160
VTP 600	3065	1300	1300	310 x 330	210 x 450	160
VTP 700	3350	1450	1400	345 x 370	240 x 540	160
VTP 800	3500	1800	1600	400 x 450	350 x 510	160
VTP 950	3655	2135	1765	450 x 500	400 x 580	250
VTP 1100	3900	2300	1950	540 x 590	450 x 750	250
VTP 1300	4635	2565	2350	650 x 710	500 x 1000	250
VTP 1500	4680	3190	2930	770 x 800	860	355
VTP 1650	5550	3600	3200	850 x 900	1000	355
VTP 1800	5595	4090	3640	930 x 1000	1070	355
VTP 1950	6190	4175	3755	1050 x 1060	1200	400
VTP 2100	6650	4590	4175	1130 x 1165	1300	400
VTP 2250	6670	4830	4250	1245 x 1245	1400	400
VTP 2400	8050	5100	4440	1300 x 1350	1460	400
VTP 2550	8350	5500	4800	1400 x 1450	1600	500
VTP 2700	8605	5845	5200	1500 x 1535	1710	500
VTP 2900	9395	6460	5730	1635 x 1650	1910	600
VTP 3100	10,000	6700	5950	1720 x 1800	2000	600
VTP 3300	11,390	6960	6180	1800 x 1920	2100	600
VTP 3600	11,840	7625	6800	2000 x 2070	2280	600
VTP 3900	12,200	8300	7400	2200 x 2350	2500	800
VTP 4200	10,380	9000	8060	2370 x 2430	2700	800
VTP 4500	11,500	9800	8600	2520 x 2620	2880	1000
VTP 4900	12,500	10,500	9200	2760 x 2870	3150	1000



Air separator VTP 2400 at the cement grinding plant with a capacity of 72 t/h – Lukavac, Bosnia and Herzegovina

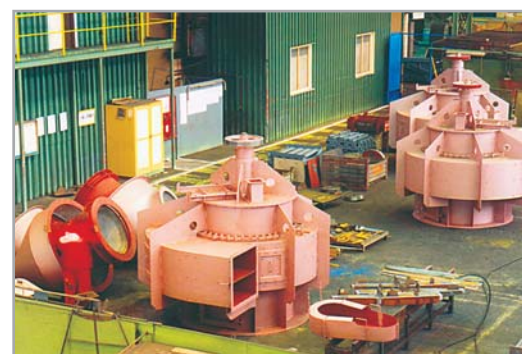

Assembly of VTP 1500 air separators for a cement grinding plant in Brazil



Air separator VTP 2900 at the cement grinding plant with a capacity of 130t/h – Galatina, Italy

Applications

1. Grinding plant with cyclones

The stated design is used when cooling is not required with the grinding process. It is only necessary to exhaust the false air drawn to the separator circuit by means of the mill filter.

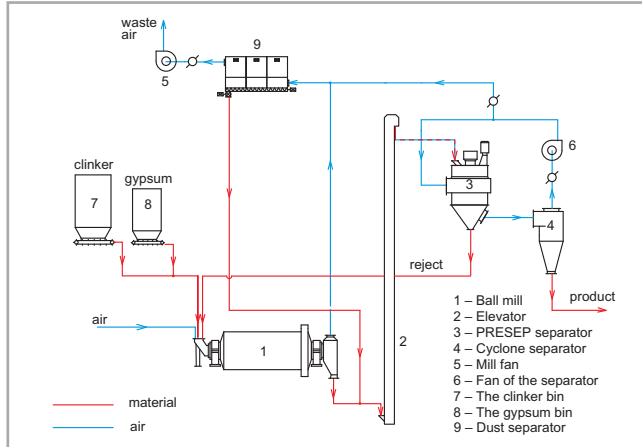

2. Grinding plant with filter when the air is taken from the mill via the separator

The stated design allows product cooling in the separator without an independent cooler. The product is separated in the filter. The airflow in the grinding circuit is simplified and the design is more compact, however the control system for the mill and separator is more complex.

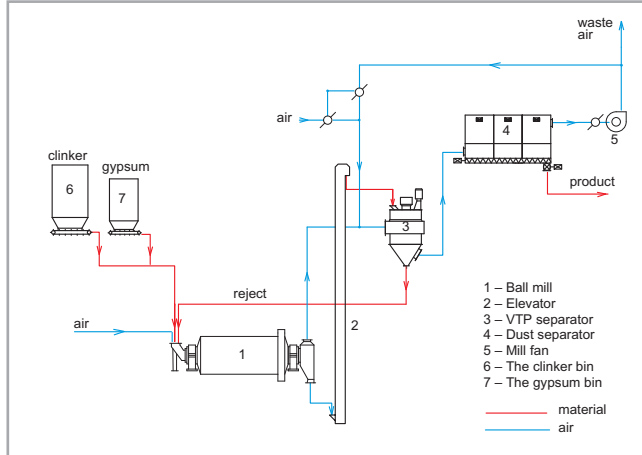

3. Grinding plant with filter and independent mill dedusting

The design allows maximum cooling of the product in the separator. The product is separated in the filter. The process regulation in the mill and separator is improved. The arrangement is suitable for grinding a product with a higher fineness.

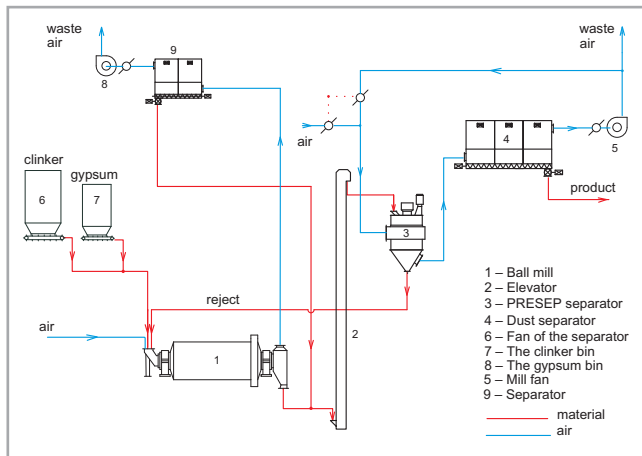

Air separator VTP 1100 at the limestone grinding plant for 9 t/h at Redipuglia, Italy



Lower part of the air separator VTP 2900 with exhaust duct at the cement grinding plant for 130 t/h at Anhovo, Slovenia

Reference of separators VTP

Customer	Locality	Country	Year	Type	Capacity	Material	Grinding fineness	Mill dimensions	Qnt.
					t/h			m	pc
Dyckerhoff	Hranice	Czech Rep.	2004	VTP 2400	95	cement	3500 Blaine	3 mills 2,5 x 13,25	1
Zanjan Cement	Zanjan	Iran	2004	VTP 2100	60	raw	12% R90	3,5 x 9,1	1
Fortuzzi	Calabrie	Italy	2004	VTP 1300	30	dolomite	3% R75		1
Jugcement	Olshanskoe	Ukraine	2004	VTP 1950	55	cement	3200 Blaine	3,2 x 15	1
PCL	Ladce	Slovakia	2004	VTP 2900	110	cement	3300 Blaine	4,2 x 14,5	1
Kotouč	Štramberk	Czech Rep.	2003	VTP 2700	43	slag	4500 Blaine	4,2 x 10,5	1
Cemmac	Horné Smie	Slovakia	2002	VTP 2700	80	cement	3500 Blaine	4,0 x 13,75	1
Sermat		Vietnam	2002	VTP 600	3	granite	5 % R45		1
Entech	Sassuolo	Italy	2002	VTP 950	27	limestone			2
FCL	Lukavac	Bosnia and Herzegovina	2002	VTP 2400	72	cement	3400 Blaine	3,8 x 13	1
CHKZ Chlumčany	Meclov	Czech Rep.	2002	VTP 1100	5	spar	2 % R63	2,8 x 5,4	1
FCL	Lukavac	Bosnia and Herzegovina	2002	VTP 2700	80	cement	3600 Blaine	4,0 x 13,75	1
Italcementi	Arrigorriaga	Spain	2001	VTP 2400	80	cement	3800 Blaine	3,8 x 12	1
Salonit Anhovo	Anhovo	Slovenia	2001	VTP 2900	130	cement	3500 Blaine	4,4 x 14	1
Italcementi	Layoune	Morocco	2000	VTP 1950	42	cement	3900 Blaine	2,9 x 10,4	1
Fortuzzi	Calabrie	Italy	2000	VTP 1100	12	limestone	10 % R 50	2,0 x 8	1
Fercalx	Taranto	Italy	2000	VTP 1500	20	slaked lime	10 % R 90		1
Dyckerhoff	Hranice	Czech Rep.	2000	VTP 2400	70	cement	3500 Blaine	2,5 x 13,25 2,7 x 13,25	1
GIJS	Itapetinga	Brazil	1999	VTP 1800	35	cement	3 700 Blaine	2,6 x 13	1
Colacem	Sesto Campano	Italy	1999	VTP 4200	300	cem. mat.	16 % R 90	5,4 x 11	1
ECMEI	Ramadan City	Egypt	1999	VTP 600	1	spar	8 % R 90	1,9 x 3,5	1
Nasir Bonyad	Shahr-E-Kord	Iran	1999	VTP 2700	115	cem. mat.	12 % R 90	3,4 x 11	1
Nasir Bonyad	Shahr-E-Kord	Iran	1999	VTP 2700	90	cement	3200 Blaine	4,2 x 13	1
Vápenka Vitošov	Vitošov	Czech Rep.	1999	VTP 1300	30	limestone	0,09-0,5mm	3,1 X 4,5	1
Colacem	Galatina	Italy	1998	VTP 2900	130	cement	3300 Blaine	4,2 x 13	1
Entech	Benevento	Italy	1998	VTP 600	4	quartz	20 % R 44	1,65 x 12	1
Italcementi	Trakya	Turkey	1998	VTP 2400	70	cement	3200 Blaine	3,8 x 11	1
Santos Gijs	Itabira	Brazil	1998	VTP 2700	67	cement	4500 Blaine	4,2 x 10,5	1
Santos Gijs	Itabira	Brazil	1998	VTP 2900	86	cement	4500 Blaine	4,2 x 13,5	1
Santos Gijs	Itaguassu	Brazil	1998	VTP 3300	118	cement	3700 Blaine	4,2 x 13,5	1
Cerfrit	Nules	Spain	1998	VTP 700	2	sintered glass	2 % R 44	Attritor	1
Entech	Reggio Emilia	Italy	1998	VTP 600	3	chromite	2 % R 40	1,8 x 2,15	1
Sermat	Redipuglia	Italy	1998	VTP 1100	9	limestone	2 % R 60	2,5 x 10	1
Cement. Katav	Katav Ivanovsk	Russia	1997	VTP 2100		cement	3400 Blaine		1
Lafarge	Kujawy	Poland	1997	VTP 2400	100	cement	3200 Blaine	4,0 x 12	1
Vápenka Vitošov	Vitošov	Czech Rep.	1997	VTP 1100	20	limestone	5 % R 90		1
Estahban Cement	Estahban	Iran	1997	VTP 1800	45	cement	3000 Blaine	3,0 x 12,5	1
Holderbank	Hirocem Rohožník	Slovakia	1996	VTP 2900	120	cement	3200 Blaine	4,4 x 15	1
Santos GIJS	Itapesoca	Brazil	1996	VTP 1500	25	cement	3200 Blaine	2,2 x 13	3
Santos GIJS	Capanema	Brazil	1996	VTP 1500	25	cement	3200 Blaine	2,2 x 13	4
PCL	Ladce	Slovakia	1996	VTP 1800	36	cement	3400 Blaine	3,1 x 6	1

PSP Engineering a.s.
 Kojetinská 3186/79
 750 53 Přerov, Czech Republic
 Tel.: +420 581 232 555
 Fax +420 581 232 905
 e-mail: info@pspeng.cz
 www.pspengineering.cz



Grinding system/PRESEP air separator VTP EN 08/2013

The producer reserves the right to modify products and/or their parameters without previous notification.

©2013 PSP Engineering a.s.